

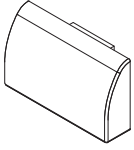

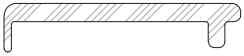
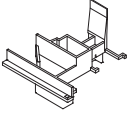
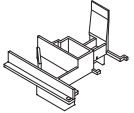

ares architectural®
systems

WD 71

Aksesuarlar
Accessories

TAPALAR ve AKSESUARLAR / PLUGS and ACCESSORIES

Ürün Çizimi Drawing	Sistem Kodu System Code	Ürünün Adı Description	Malzeme Material	mt/ koli mt/ box
	PV.001	KAPI ALTI FIRÇASI WHEATHER STRIP BRUSH FOR DOOR	POLİPROPİLENE (PP)	
	PV.002	SU TAHLİYE TAPASI WATER DRAINAGE PLUG	PVC	
	PV.003 C	CAM ALTI DESTEK PARÇASI (KANAT İÇİN) GLAZING SUPPORT (FOR SASH)	PVC	
	PV.008	ÇİFT KANAT ADAPTÖR TAPASI ADAPTER PLUG FOR DOUBLE SASH (71 A 03)	PVC	
	PV.009	ÇİFT KANAT ADAPTÖR TAPASI ADAPTER PLUG FOR DOUBLE SASH (71 A 04)	PVC	
	EG.009	KAPI ETEK İÇ BİNİ FİTİLİ INNER GASKET FOR DOOR KICK PLATE	EPDM	454 mt / 15 kg
	EG.010	KAPI ETEK DIŞ BİNİ FİTİLİ OUTER GASKET FOR DOOR KICK PLATE	EPDM	156 mt / 13 kg
	EG.015 55 gr	KANAL KAPAMA FİTİLİ CLOSING GASKET	EPDM	180 mt / 15,2 kg

FİTİLLER / GASKETS				
Ürün Çizimi Drawing	Sistem Kodu System Code	Ürünün Adı Description	Malzeme Material	mt/koli mt/box
	EG.701 76 gr	DIŞ CAM FİTİLİ OUTER GLAZING GASKET	EPDM	195 mt / 15 kg
	EG.702 65 gr	İÇ CAM FİTİLİ 2 mm INNER GLAZING GASKET	EPDM	230 mt / 15 kg
	EG.703 73 gr	İÇ CAM FİTİLİ 3-4 mm INNER GLAZING GASKET	EPDM	205 mt / 15 kg
	EG.704 102 gr	İÇ CAM FİTİLİ 5-6 mm INNER GLAZING GASKET	EPDM	145 mt / 15 kg
	EG.005 30 gr	İÇ BİNİ FİTİLİ INNER GASKET FOR SASH	EPDM	480 mt / 15 kg
	EG.006 25 gr	DIŞ BİNİ FİTİLİ OUTER GASKET FOR SASH	EPDM	425 mt / 15 kg
	EG.071 352 gr	ORTABİNİ FİTİLİ CENTRAL GASKET	EPDM	35 mt / 15 kg
	EG.008-71	EG.071 İÇİN VULKANİZE FİTİL CORNER GASKET FOR CENTRAL GASKET EG.071	EPDM	adet / piece

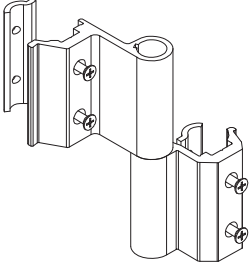
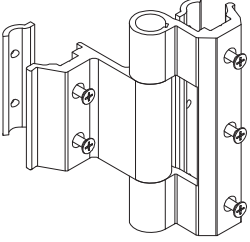
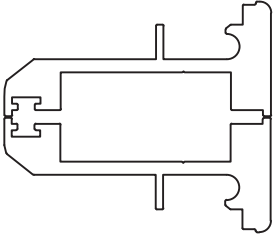
MENTEŞELER / HINGES		
Ürün Çizimi Drawing	Sistem Kodu System Code	Ürünün Adı Description
	AH.001	PENCERE MENTEŞESİ WINDOW HINGE
	AH.002	ÜÇLÜ PENCERE MENTEŞESİ WINDOW TRIPLE HINGE
	AH.005	PİVOT PENCERE MENTEŞESİ PIVOT WINDOW HINGE

KÖŞE HİZALAMA PARÇASI / PLASTIC PART FOR CORNER ALIGNMENT

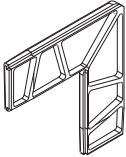
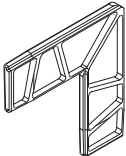
Ürün Çizimi Drawing	Sistem Kodu System Code	Ürünün Adı Description	Malzeme Material
	CS.01	KÖŞE HİZALAMA CORNER ALIGNMENT	PVC
	CS.02	KÖŞE HİZALAMA CORNER ALIGNMENT	PVC

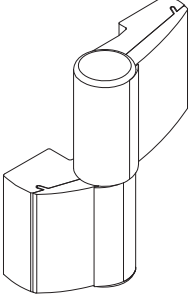
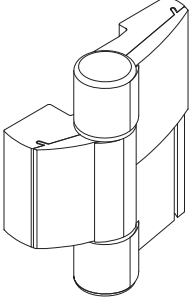
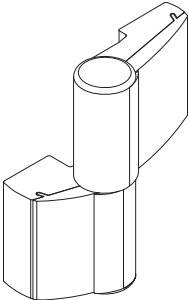
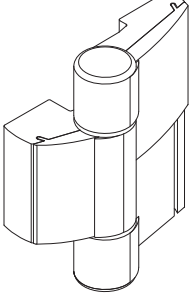
MENTEŞELER / HINGES		
Ürün Çizimi Drawing	Sistem Kodu System Code	Ürünün Adı Description
	KH 01	BİNİLİ KAPI MENTEŞESİ STEP DOOR HINGE
	KH 02	HEMYÜZ KAPI MENTEŞESİ FLAT DOOR HINGE
	KH 03	BİNİLİ ÜÇLÜ KAPI MENTEŞESİ STEP DOOR TRIPLE HINGE
	KH 04	HEMYÜZ ÜÇLÜ KAPI MENTEŞESİ FLAT DOOR TRIPLE HINGE
MENTEŞELER / HINGES		
Ürün Çizimi Drawing	Sistem Kodu System Code	Ürünün Adı Description
	KH 05	HEMYÜZ DIŞA AÇILIR KAPI MENTEŞESİ FLAT DOOR OUTWARD OPENING HINGE
	KH 06	HEMYÜZ DIŞA AÇILIR 3'LÜ KAPI MENTEŞESİ FLAT DOOR OUTWARD OPENING TRIPLE HINGE

İSPANYOLET KOL / ESPAGNOLETTE HANDLE

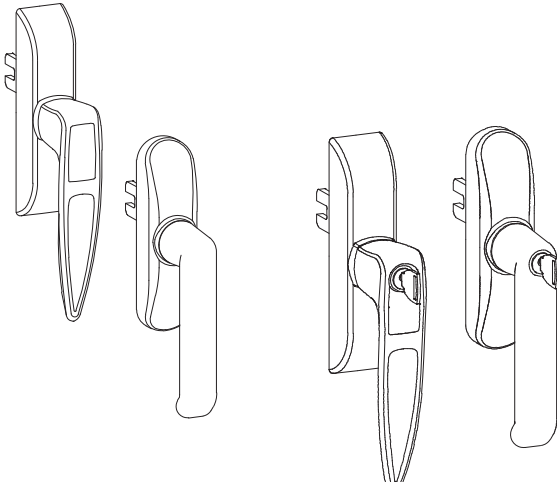
Ürün Çizimi Drawing	Sistem Kodu System Code	Ürünün Adı Description
	PPA 01	İSPANYOLET KOL ESPAGNOLETTE HANDLE
	PPA 02	KİLİTLİ İSPANYOLET KOL ESPAGNOLETTE HANDLE WITH LOCK
	PPA 03	İSPANYOLET KOL ESPAGNOLETTE HANDLE
	PPA 04	KİLİTLİ İSPANYOLET KOL ESPAGNOLETTE HANDLE WITH LOCK



PENCERE AÇILIM AKSESUARLARI / WINDOW OPENING ACCESSORIES

Ürün Çizimi Drawing	Sistem Kodu System Code	Ürünün Adı Description
	WH.01.11	AYARLI KARŞILIK ADJUSTABLE KEEPER
	WH.01.12	Tij PİMİ PIN

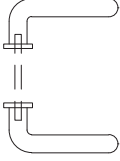
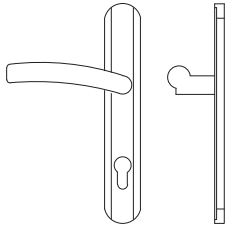
BASMA KAPI KOLLARI / DOOR HANDLES

Ürün Çizimi Drawing	Sistem Kodu System Code	Ürünün Adı Description
	KPA 08	BASMA KAPI KOLU DOOR HANDLE
	KPA 09	ROZETLİ KAPI KOLU MONOBLOCK DOOR HANDLE

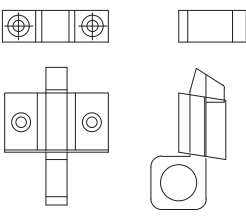
VASİSTAS AKSESUARLARI / VASİSTAS ACCESSORIES

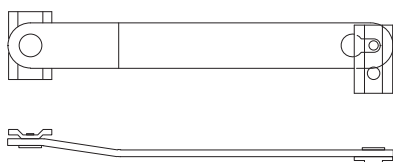
Ürün Çizimi Drawing	Sistem Kodu System Code	Ürünün Adı Description
	VAA 01	VASİSTAS ÇARPMA VASİSTAS ACCESSORY
	VAA 02	ÇELİK VASİSTAS MAKASI STEEL VASİSTAS FRICTION STAY
	VAA 03	ALÜMİNYUM VASİSTAS MAKASI ALUMINIUM VASİSTAS FRICTION STAY

ÇİFT AÇILIM SİSTEMİ
DOUBLE OPENING SYSTEM

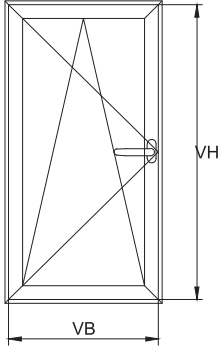

		VB		
		355-600	601-1249	1250-1600
VH	500-1249	AA 01	AA 03	AA 05
	1250-2000	AA 02	AA 04	AA 06

ÇİFT AÇILIM ÇİFT KANAT SİSTEMİ
DOUBLE OPENING FOR DOUBLE SASH SYSTEM

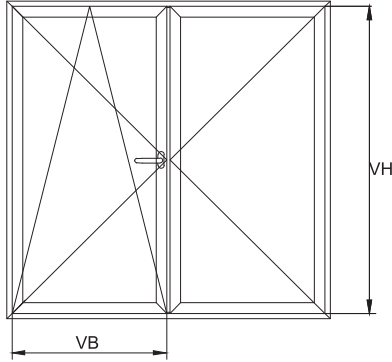

		VB		
		355-600	601-1249	1250-1600
VH	500-1249	AA 11	AA 13	AA 15
	1250-2000	AA 12	AA 14	AA 16

*Setlere; 1251-1600 mm genişlik ölçülerinde alt kilitleme, 1251-2400mm yüksekliklerinde arka kilitleme dahildir.

*Setlere kol dahildir.

*Siparişlerde set renkleri belirtilmelidir.

*Sets include bottom lockings with 1251-1600mm width dimensions and rear lockings with 1251-2400mm height.

*Handles are included in the sets.

*Color codes should be specified at orders.

	Pencereleler / Windows		Kapılar / Doors max.
	min.	max.	
VB	355	1600	1300
VH	500	2000	2400
VG	Max. 130 kg		Max. 130 kg

VB: KANAT GENİŞLİĞİ
SASH WIDTH

VG: KANATAĞIRLIĞI
SASH WEIGHT

VH: KANAT YÜKSEKLİĞİ
SASH HEIGHT

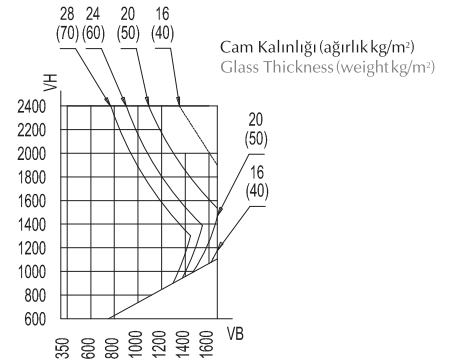

PVC KANALLI ÇİFT AÇILIM SİSTEMİ
DOUBLE OPENING SYSTEM WITH PVC CHANNEL

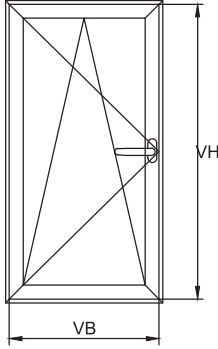

- * Setlere, arka kilitlemeler ve kol dahil değildir.
- * Siparişlerde renk belirtilmelidir.
- * Çift kanatta, pasif taraf menteşe grupları ve ispanyolet karşılıkları dahildir.
- * Çift kanatta, pasif kanadın orta baskı menteşesi VH1460mm'den itibaren dahildir.
- * Rear locks and handles are not included in the sets.
- * Color should be specified at orders.
- * In the double wing, passive side hinge groups and espagnolette counterparts are included.
- * At double-sash system, passive side hinges are included after VH 1460mm size.

		VB		
		355-600	601-1249	1250-1600
VH	480-600	PA 01	PA 07	PA 13
	601-1100	PA 02	PA 08	PA 14
	1101-1180	PA 03	PA 09	PA 15
	1180-1460	PA 04	PA 10	PA 16
	1461-1920	PA 05	PA 11	PA 17
	1921-2360	PA 06	PA 12	PA 18

PVC KANALLI ÇİFT AÇILIM ÇİFT KANAT SİSTEMİ
DOUBLE OPENING DOUBLE SASH SYSTEM WITH PVC CHANNEL

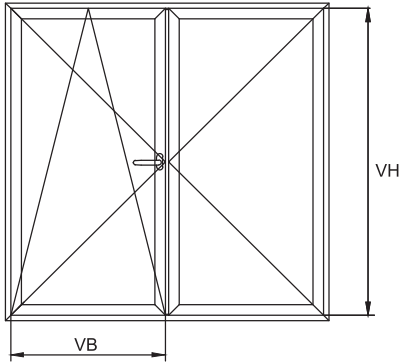

		VB		
		355-600	601-1249	1250-1600
VH	480-600	PA 20	PA 26	PA 32
	601-1100	PA 21	PA 27	PA 33
	1101-1180	PA 22	PA 28	PA 34
	1180-1460	PA 23	PA 29	PA 35
	1461-1920	PA 24	PA 30	PA 36
	1921-2360	PA 25	PA 31	PA 37

Ürün Kodu Product Code	Ürün Açıklaması Product Description	Kullanım Aralığı Range of Use
PAK.01	Arka Kilitleme 50 Rear Locking 50	1000-1460
PAK.02	Arka Kilitleme 90 Rear Locking 90	1461-1920
PAK.03	Arka Kilitleme 130 Rear Locking 130	1800-2360

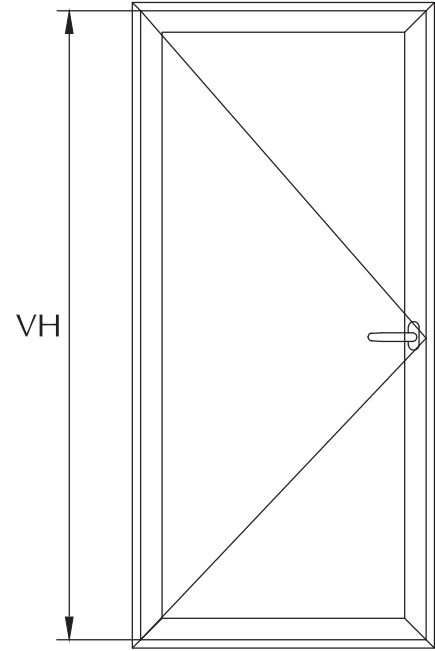

PVC KANALLI VE ALÜMİNYUM TİJLİ BALKON
KAPILARI İÇİN AKSESUAR TAKIMLARI
ACCESSORY KITS FOR BALCONY DOORS WITH
PVC CHANNEL AND ALUMINIUM CHANNEL

Ürün Kodu Product Code	Ürün Açıklaması Product Description
KA.01	Alu. kanal için kilitleme takımı Locking set for aluminium channel
KA.02	PVC kanal için ispanyolet kilitleme takımı Espagnolette locking kit for PVC channel
KA.03	Alu. kanal için çift kanat kilitleme takımı Double wing locking kit for aluminium channel
KA.04	PVC kanal için çift kanat kilitleme takımı Double wing locking kit for PVC channel
KA.05	Alu. kanal için kilitli ispanyolet takımı Espagnolette locking set for aluminium channel
KA.06	PVC kanal için kilitli ispanyolet takımı Espagnolette locking set for PVC channel
KA.07	Alu. kanal için çift kanat kilitli ispanyolet takımı Double wing espagnolette locking set for aluminium channel
KA.08	PVC kanal için çift kanat kilitli ispanyolet takımı Double wing espagnolette locking set for PVC channel
KA.09	Alu. kanal için çok noktadan kilitleme takımı (koldan kumandalı) Multi-point locking set for aluminium channel (handle operated)
KA.10	PVC kanal için çok noktadan kilitleme takımı (koldan kumandalı) Multi-point locking set for PVC channel (handle operated)
KA.11	Alu. kanal için çok noktadan kilitleme takımı (barel kumandalı) Multi-point locking set for aluminium channel (barrel operated)
KA.12	PVC kanal için çok noktadan kilitleme takımı (barel kumandalı) Multi-point locking set for PVC channel (barrel operated)

KAPI KİLİTLEME AKSESUARLARI / DOOR LOCKING ACCESSORIES

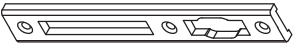
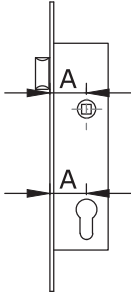
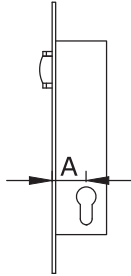
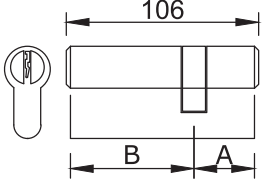
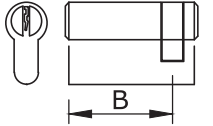
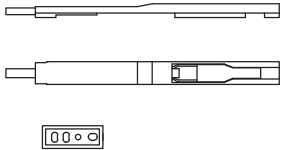
Ürün Çizimi Drawing	Sistem Kodu System Code	Ürünün Adı Description
	KPA.01	DİLLİ KİLİT KARŞILIĞI DOOR LOCK KEEPER Renk ayrıca belirtilmelidir Color must be specified
	KPA.02	MAKARALI KİLİT KARŞILIĞI DOOR ROLLER LOCK KEEPER Renk ayrıca belirtilmelidir Color must be specified
 <p>A: 30 mm A: 35 mm</p>	KPA.03	DİLLİ KİLİT LOCK
 <p>A: 30 mm A: 35 mm</p>	KPA.04	MAKARALI KİLİT ROLLER LOCK
 <p>106 B A</p>	KPA.09	106'LIK BAREL BARREL 106
 <p>B</p>	KPA.06	YARIM BAREL HALF BARREL
	KPA.07	ÇİFT KANAT SÜRGÜ DOUBLE WING SLIDE