

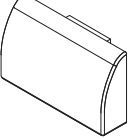

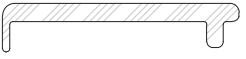

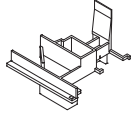

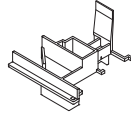

# WD 55 NI

**Aksesuarlar**  
*Accessories*

TAPALAR / PLUGS

| ÜRÜN ÇİZİMİ<br>DRAWING  | SİSTEM KODU<br>SYSTEM CODE | ÜRÜNÜN ADI<br>DESCRIPTION  | MALZEME<br>MATERIAL | mt/koli<br>mt/box |
|---|----------------------------|--|---------------------|-------------------|
|              | PV.001                     | KAPI ALTI FIRÇASI<br>WHEATHER STRIP BRUSH FOR DOOR                         | POLİPROPİLENE       |                   |
|              | PV.002                     | SU TAHLİYE TAPASI<br>PLUG FOR WATER DRAINAGE                               | PVC                 |                   |
| <br>ÖLÇEKSİZ | PV.003                     | CAM ALTI DESTEK PARÇASI<br>GLAZING SUPPORT<br>KANAT İÇİN / FOR VENT        | PVC                 |                   |
|             | PV.004                     | ÇİFT KANAT ADAPTÖR TAPASI<br>ADAPTER PLUG FOR DOUBLE VENT<br>(55 NI A 03 ) | PVC                 |                   |
|            | PV.005                     | ÇİFT KANAT ADAPTÖR TAPASI<br>ADAPTER PLUG FOR DOUBLE VENT<br>(55 NI A 04 ) | PVC                 |                   |
|            | EG.009                     | KAPI ETEK İÇ BİNİ FİTİLİ<br>DOOR BOTTOM INNER GASKET                       | EPDM                |                   |
|            | EG.010                     | KAPI ETEK DIŞ BİNİ FİTİLİ<br>DOOR BOTTOM OUTER GASKET                      | EPDM                |                   |
|   |                            |  |                     |                   |

FİTİLLER / GASKETS

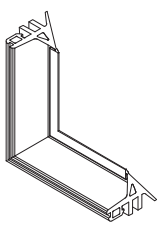
| ÜRÜN ÇİZİMİ<br>DRAWING  | SİSTEM KODU<br>SYSTEM CODE | ÜRÜNÜN ADI<br>DESCRIPTION   | MALZEME<br>MATERIAL | mt/15kg<br>mt/box |
|---|----------------------------|---|---------------------|-------------------|
|    | EG.001<br>72 gr            | DIŞ CAM FİTİLİ<br>OUTER GLAZING GASKET                                    | EPDM                | 205 mt / 15kg     |
|    | EG.002<br>32 gr            | İÇ CAM FİTİLİ 2mm<br>INNER GLAZING GASKET                                 | EPDM                | 465 mt / 15kg     |
|    | EG.003<br>39 gr            | İÇ CAM FİTİLİ 3-4mm<br>INNER GLAZING GASKET                               | EPDM                | 385 mt / 15kg     |
|  | EG.004<br>69 gr            | İÇ CAM FİTİLİ 5-6mm<br>INNER GLAZING GASKET                               | EPDM                | 215 mt / 15kg     |
|  | EG.005<br>29 gr            | İÇ BİNİ FİTİLİ<br>GASKET FOR INNER RABBET                                 |                     | 515 mt / 15kg     |
|  | EG.006<br>25 gr            | DIŞ BİNİ FİTİLİ<br>GASKET FOR OUTER RABBET                                | EPDM                | 500 mt / 12,5kg   |
|  | EG.011<br>179 gr           | ORTA BİNİ FİTİLİ<br>CENTRAL GASKET  | EPDM                | 83 mt / 15kg      |
|  | EG.012                     | EG.011 İÇİN VULKANİZE FİTİL<br>CORNER GASKET FOR CENTRAL<br>GASKET EG.011 | EPDM                | adet              |

## MENTEŞELER

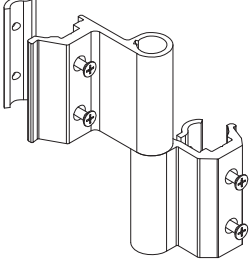
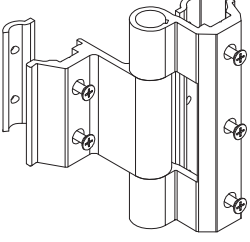
| ÜRÜN ÇİZİMİ  | SİSTEM KODU | ÜRÜNÜN ADI             |
|--|-------------|------------------------|
|   | AH.001      | PENCERE MENTEŞESİ      |
|  | AH.002      | ÜÇLÜ PENCERE MENTEŞESİ |

## KÖŞE ONBAŞI

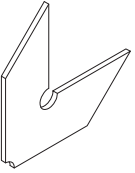

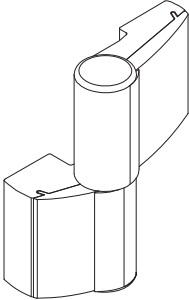
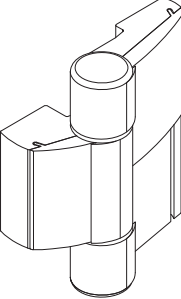
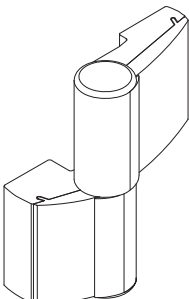
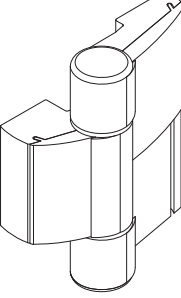
| ÜRÜN ÇİZİMİ   | SİSTEM KODU | ÜRÜNÜN ADI  | MALZEME |
|---|-------------|-------------|---------|
|  | CS.01       | KÖŞE ONBAŞI | ÇELİK   |

| MENTEŞELER  |             |                                       |
|---|-------------|---------------------------------------|
| ÜRÜN ÇİZİMİ   | SİSTEM KODU | ÜRÜNÜN ADI                            |
|    | KH 01       | BİNİLİ KAPI MENTEŞESİ                 |
|   | KH 02       | HEMYÜZ KAPI MENTEŞESİ                 |
|   | KH 03       | BİNİLİ ÜÇLÜ KAPI MENTEŞESİ            |
|   | KH 04       | HEMYÜZ ÜÇLÜ KAPI MENTEŞESİ            |
| MENTEŞELER  |             |                                       |
| ÜRÜN ÇİZİMİ   | SİSTEM KODU | ÜRÜNÜN ADI                            |
|  | KH 05       | HEMYÜZ DIŞA AÇILIR KAPI MENTEŞESİ     |
|  | KH 06       | HEMYÜZ DIŞA AÇILIR 3LÜ KAPI MENTEŞESİ |

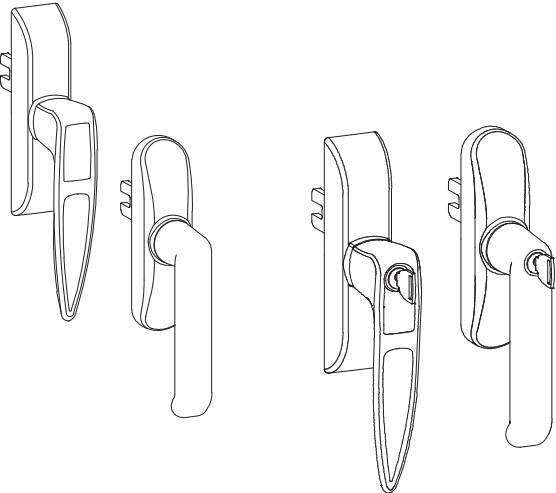
İSPANYOLET KOL

| ÜRÜN ÇİZİMİ  | SİSTEM KODU | ÜRÜNÜN ADI                     |
|--|-------------|--------------------------------|
|  | PPA 01      | İSPANYOLET KOL                 |
|  | PPA 02      | KİLİTLİ İSPANYOLET KOL         |
|  | PPA 03      | İSPANYOLET KOL (İTHAL)         |
|  | PPA 04      | KİLİTLİ İSPANYOLET KOL (İTHAL) |

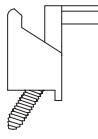
AÇILIM AKSESUARLARI / OPENING ACCESSORIES

| ÜRÜN ÇİZİMİ<br>DRAWING  | SİSTEM KODU<br>SYSTEM CODE | ÜRÜNÜN ADI<br>DESCRIPTION            |
|---|----------------------------|--------------------------------------|
|  | WH.01.11                   | AYARLI KARŞILIK<br>ADJUSTABLE KEEPER |
|  | WH.01.12                   | TİJ PİMİ<br>PIN                      |

BASMA KAPI KOLLARI

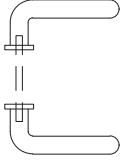
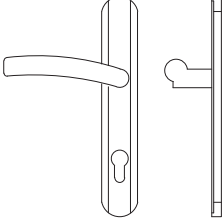
| ÜRÜN ÇİZİMİ   | SİSTEM KODU | ÜRÜNÜN ADI        |
|---|-------------|-------------------|
|  | KPA 08      | BASMA KAPI KOLU   |
|  | KPA 09      | ROZETLİ KAPI KOLU |

VASİSTAS AKSESUARLARI

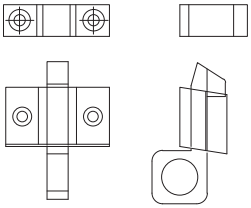
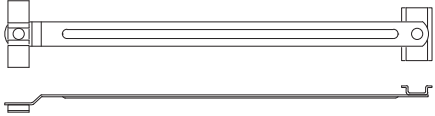
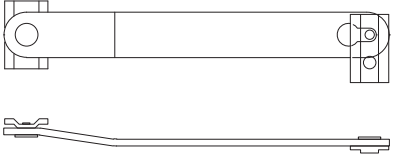
| ÜRÜN ÇİZİMİ   | SİSTEM KODU | ÜRÜNÜN ADI                |
|---|-------------|---------------------------|
|  | VAA 01      | VASİSTAS ÇARPMA           |
|  | VAA 02      | ÇELİK VASİSTAS MAKASI     |
|  | VAA 03      | ALÜMİNYUM VASİSTAS MAKASI |

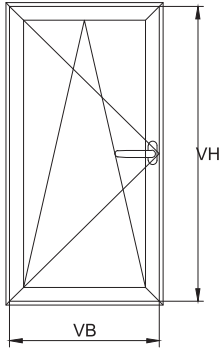

### ÇİFT AÇILIM SİSTEMİ

|    |           | VB      |          |           |
|----|-----------|---------|----------|-----------|
|    |           | 355-600 | 601-1249 | 1250-1600 |
| VH | 500-1249  | AA 01   | AA 03    | AA 05     |
|    | 1250-2000 | AA 02   | AA 04    | AA 06     |

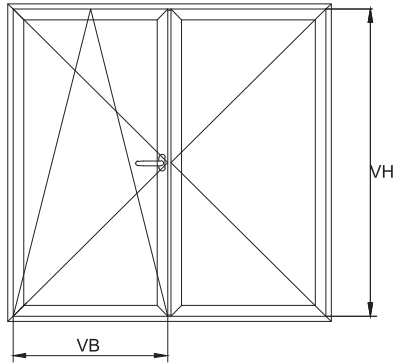

### ÇİFT AÇILIM ÇİFT KANAT SİSTEMİ

|    |           | VB      |          |           |
|----|-----------|---------|----------|-----------|
|    |           | 355-600 | 601-1249 | 1250-1600 |
| VH | 500-1249  | AA 11   | AA 13    | AA 15     |
|    | 1250-2000 | AA 12   | AA 14    | AA 16     |

- Setlere ; 1251-1600 genişlik ölçülerinde alt kilitleme, 1251-2400 yüksekliklerinde arka kilitleme dahildir
- Setlere kol dahil değildir.
- Siparişlerde set renkleri belirtilmelidir.

|    | Pencereler  |       | Kapılar<br>maks. |
|----|-------------|-------|------------------|
|    | min.        | maks. |                  |
| VB | 355         | 1600  | 1300             |
| VH | 500         | 2000  | 2400             |
| VG | Maks. 130kg |       | Maks. 130kg      |

VB=KANAT GENİŞLİĞİ

VG=KANAT AĞIRLIĞI

VH=KANAT YÜKSEKLİĞİ

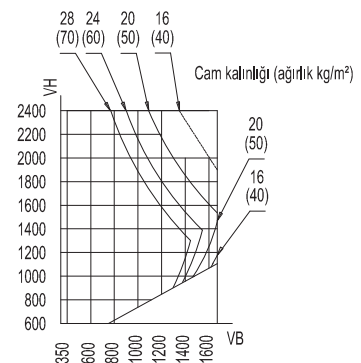



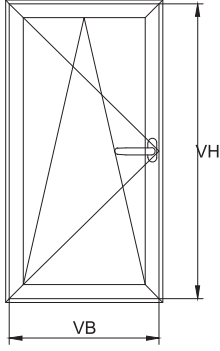

- Setlere, arka kilitlemeler ve kol dahil değildir.
- Siparişlerde renk belirtilmelidir.
- Çift kanatta pasif taraf menteşe grupları ve ispanyolet karşılıkları dahildir.
- Çift kanatta pasif kanat orta gizli baskı menteşe VH 1460mm den itibaren dahildir.

### PVC KANALLI ÇİFT AÇILIM SİSTEMİ

|    |           | VB      |          |           |
|----|-----------|---------|----------|-----------|
|    |           | 355-600 | 601-1249 | 1250-1600 |
| VH | 480-600   | PA 01   | PA 07    | PA 13     |
|    | 601-1100  | PA 02   | PA 08    | PA 14     |
|    | 1101-1180 | PA 03   | PA 09    | PA 15     |
|    | 1181-1460 | PA 04   | PA 10    | PA 16     |
|    | 1461-1920 | PA 05   | PA 11    | PA 17     |
|    | 1921-2360 | PA 06   | PA 12    | PA 18     |

### PVC KANALLI ÇİFT AÇILIM ÇİFT KANAT SİSTEMİ

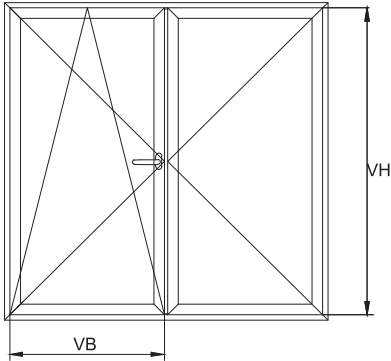

|    |           | VB      |          |           |
|----|-----------|---------|----------|-----------|
|    |           | 355-600 | 601-1249 | 1250-1600 |
| VH | 480-600   | PA 20   | PA 26    | PA 32     |
|    | 601-1100  | PA 21   | PA 27    | PA 33     |
|    | 1101-1180 | PA 22   | PA 28    | PA 34     |
|    | 1181-1460 | PA 23   | PA 29    | PA 35     |
|    | 1461-1920 | PA 24   | PA 30    | PA 36     |
|    | 1921-2360 | PA 25   | PA 31    | PA 37     |

| Ürün kodu | Ürün açıklaması    | Kullanım aralığı |
|-----------|--------------------|------------------|
| PAK.01    | Arka kilitleme 50  | 1000-1460        |
| PAK.02    | Arka kilitleme 90  | 1461-1920        |
| PAK.03    | Arka kilitleme 130 | 1800-2360        |

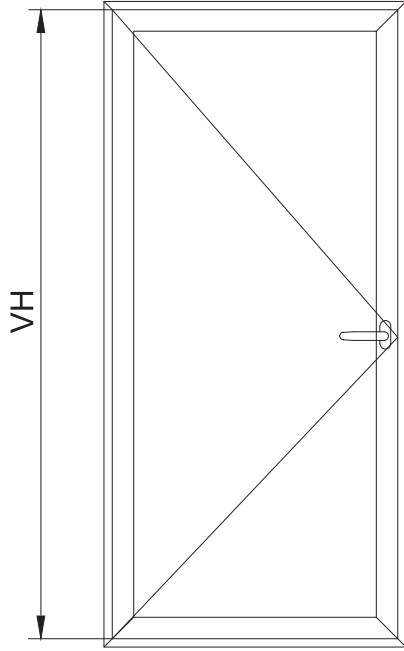
**PVC KANALLI VE ALÜMİNYUM TİJLİ BALKON  
KAPILARI İÇİN AKSESUAR TAKIMLARI**

| Ürün kodu | Ürün açıklaması  |
|-----------|--|
| KA.01     | Alu. kanal için kilitleme takımı                                   |
| KA.02     | PVC kanal için ispanyolet kilitleme takımı                         |
| KA.03     | Alu. kanal için çift kanat kilitleme takımı                        |
| KA.04     | PVC kanal için çift kanat kilitleme takımı                         |
| KA.05     | Alu. kanal için kilitli ispanyoletli kilitleme takımı              |
| KA.06     | PVC kanal için kilitli ispanyoletli kilitleme takımı               |
| KA.07     | Alu. kanal için çift kanat kilitli ispanyoletli kilitleme takımı   |
| KA.08     | PVC kanal için çift kanat kilitli ispanyoletli kilitleme takımı    |
| KA.09     | Alu. kanal için çok noktadan kilitleme takımı ( koldan kumandalı ) |
| KA.10     | PVC kanal için çok noktadan kilitleme takımı ( koldan kumandalı )  |
| KA.11     | Alu. kanal için çok noktadan kilitleme takımı ( barel kumandalı )  |
| KA.12     | PVC kanal için çok noktadan kilitleme takımı ( barel kumandalı )   |

## KAPI KİLİTLEME AKSESUARLARI

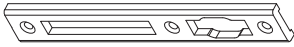
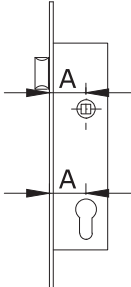
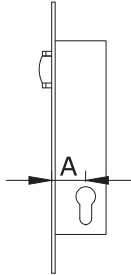
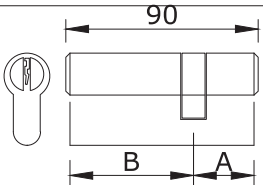
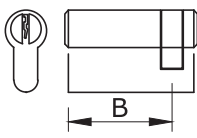
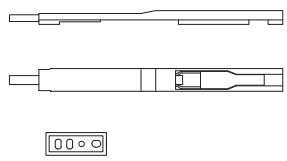
| ÜRÜN ÇİZİMİ  | SİSTEM KODU | ÜRÜNÜN ADI   |
|--|-------------|--|
|                             | KPA.01      | DİLLİ KİLİT KARŞILIĞI<br>(Renk ayrıca belirtilmelidir.)    |
|                             | KPA.02      | MAKARALI KİLİT KARŞILIĞI<br>(Renk ayrıca belirtilmelidir.) |
|  <p>A:30mm<br/>A:35mm</p>  | KPA.03      | DİLLİ KİLİT  |
|  <p>A:30mm<br/>A:35mm</p> | KPA.04      | MAKARALI KİLİT   |
|  <p>90<br/>B A</p>        | KPA.05      | 90 LİK BAREL   |
|  <p>B</p>                 | KPA.06      | YARIM BAREL  |
|                           | KPA.07      | ÇİFT KANAT SÜRGÜ   |