

CW 50

Aksesuarlar
Accessories

ares architectural[®]
systems

FİTİLLER / GASKETS

ÜRÜN ÇİZİMİ	SİSTEM KODU	ÜRÜNÜN ADI	MALZEME	mt/koli
	RG.03.010 25 gr	İç Cam Fitili - 1 mm	EPDM	575 mt / 15kg
	RG.03.030 48 gr	İç Cam Fitili - 3 mm	EPDM	300 mt / 15kg
	RG.03.050 78 gr	İç Cam Fitili - 5 mm	EPDM	185 mt / 15kg
	RG.03.070 94 gr	İç Cam Fitili -7 mm	EPDM	150 mt / 15kg
	RG.03.090 109 gr	İç Cam Fitili -9 mm	EPDM	137 mt / 15kg
	RG.03.110 122 gr	İç Cam Fitili - 11 mm	EPDM	120 mt / 15kg
	RG.03.130 130 gr	İç Cam Fitili - 13 mm	EPDM	110 mt / 15kg
	RG.03.011 70 gr	DIŞ CAM FİTİLİ	EPDM	214 mt / 15kg
	RG.03.012 44 gr	4 mm GAGA FİTİLİ	EPDM	250 mt / 12,5 kg

FİTİLLER / GASKETS



ÜRÜN ÇİZİMİ DRAWING	SİSTEM KODU SYSTEM CODE	ÜRÜNÜN ADI DESCRIPTION	MALZEME MATERIAL	mt/koli mt/box
	RG.03.013 66 gr	6 mm GAGA FİTİLİ	EPDM	200 mt / 14 kg
	RG.03.014 86 gr	8 mm GAGA FİTİLİ	EPDM	170 mt / 15 kg
	RG.03.017 43 gr	SİLİKON CEPHE KASET FİTİLİ GASKET	EPDM	335 mt / 15 kg
	RG.03.020 148 gr	KASETLİ SİLİKON CEPHE GAGA FİTİLİ	EPDM	100 mt / 15 kg
	RG.03.021	GİZLİ KANAT FİTİLİ GASKET	EPDM	
	RG.03.018	GİZLİ KANAT FİTİLİ GASKET	EPDM	
	RG.03.023 118 gr	SİLİKON FİTİL SILICONE GASKET	SİLİKON	125 mt / 15 kg

FİTİLLER / GASKETS

ÜRÜN ÇİZİMİ DRAWING	SİSTEM KODU SYSTEM CODE	ÜRÜNÜN ADI DESCRIPTION	MALZEME MATERIAL	mt/koli mt/box
	RG.03.025 113 gr	GİZLİ KANAT BİNİ FİTİLİ GASKET	EPDM	132 mt / 15 kg
	RG.03.026 73 gr	GİZLİ KANAT BİNİ FİTİLİ GASKET	EPDM	205 mt / 15 kg
	RG.03.033 56 gr	GİZLİ KANAT FİTİLİ GASKET	EPDM	260 mt / 15 kg
	RG.03.034 130 gr	GİZLİ KANAT FİTİLİ GASKET	EPDM	115 mt / 15 kg
	EG.001 72 gr	DIŞ CAM FİTİLİ OUTER GLAZING GASKET	EPDM	205 mt / 15kg
	EG.003 39 gr	İÇ CAM FİTİLİ 3-4mm INNER GLAZING GASKET	EPDM	385 mt / 15kg
	EG.004 69 gr	İÇ CAM FİTİLİ 5-6mm INNER GLAZING GASKET	EPDM	215 mt / 15kg
	EG.005 29 gr	İÇ BİNİ FİTİLİ GASKET FOR INNER RABBET	EPDM	515 mt / 15kg
	EG.006 25 gr	DIŞ BİNİ FİTİLİ GASKET FOR OUTER RABBET	EPDM	600 mt / 15kg
	EG.007 179 gr	ORTA BİNİ FİTİLİ CENTRAL GASKET	EPDM	83 mt / 15kg

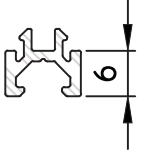
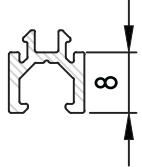
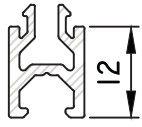
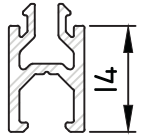
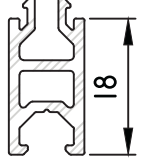
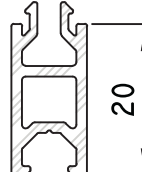
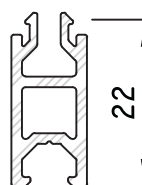
PVC İZOLATÖRLER / PVC PROFILES

ÜRÜN ÇİZİMİ DRAWING	SİSTEM KODU SYSTEM CODE	ÜRÜNÜN ADI DESCRIPTION	MALZEME MATERIAL	mt/koli mt/box
	PL.03.001	PVC İZOLATOR - 6 mm PVC PROFILE	PVC	6 mt / boy
	PL.03.002	PVC İZOLATOR - 8 mm PVC PROFILE	PVC	6 mt / boy
	PL.03.003	PVC İZOLATOR - 12 mm PVC PROFILE	PVC	6 mt / boy
	PL.03.004	PVC İZOLATOR - 15 mm PVC PROFILE	PVC	6 mt / boy
	PL.03.005	PVC İZOLATOR - 18 mm PVC PROFILE	PVC	6 mt / boy
	PL.03.006	PVC İZOLATOR - 20 mm PVC PROFILE	PVC	6 mt / boy
	PL.03.007	PVC İZOLATOR - 22 mm PVC PROFILE	PVC	6 mt / boy

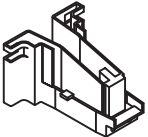
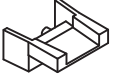
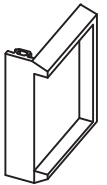
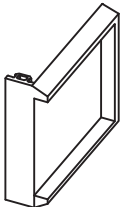
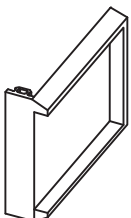
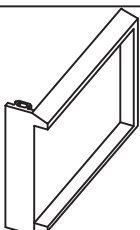
PVC VE EPDM AKSESUARLAR				
ÜRÜN ÇİZİMİ DRAWING	SİSTEM KODU SYSTEM CODE	ÜRÜNÜN ADI DESCRIPTION	MALZEME MATERIAL	mt/koli mt/box
	PL.03.011	DİLETASYON KAPAĞI	PVC	
	PL.03.012	DİLETASYON KAPAĞI ÇELİK GÖRÜNÜMLÜ CEPHE İÇİN	PVC	
	PL.03.013	DÜŞEY TAHLİYE PARÇASI	PVC	
	PL.03.014	DÜŞEY TAHLİYE EK PARÇASI	PVC	
	PL.03.015	YATAY KAYIT GENLEŞME CONTASI 56 LİK		
	PL.03.016	YATAY KAYIT GENLEŞME CONTASI 86 LİK		
	PL.03.017	YATAY KAYIT GENLEŞME CONTASI 106 LİK		
	PL.03.018	YATAY KAYIT GENLEŞME CONTASI 126 LİK		

PVC VE EPDM AKSESUARLAR

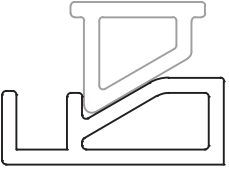
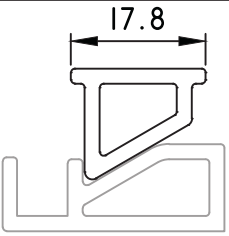

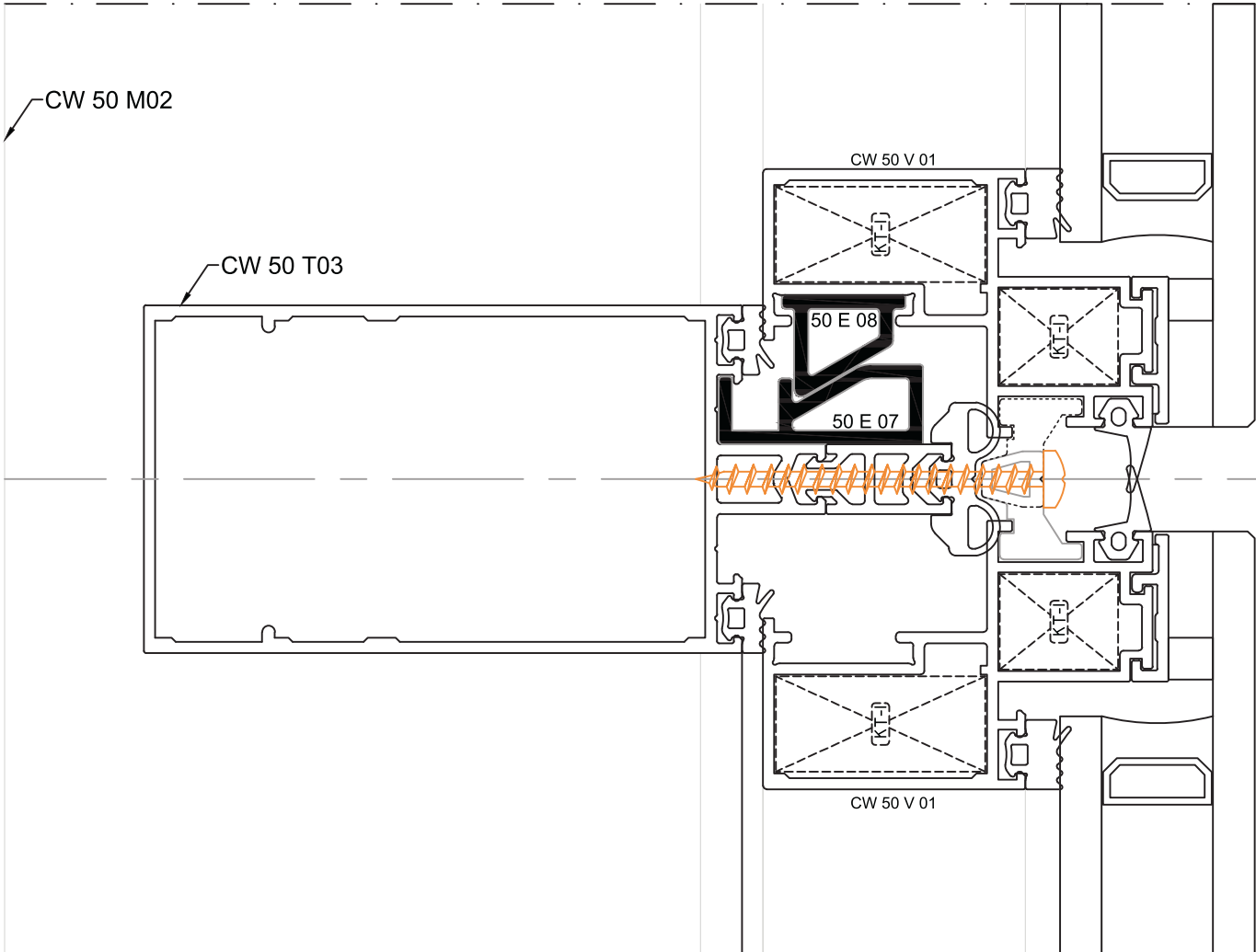
ÜRÜN ÇİZİMİ DRAWING	SİSTEM KODU SYSTEM CODE	ÜRÜNÜN ADI DESCRIPTION	MALZEME MATERIAL	mt/koli mt/box
	50 E 07	SEVİYE TESPİT TAKOZU ALT	PVC	
	50 E 08	SEVİYE TESPİT TAKOZU ÜST	PVC	

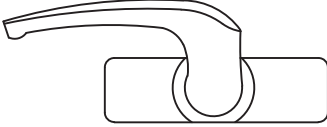

İSPANYOLET KOL / HANDLE FOR WINDOWS

ÜRÜN ÇİZİMİ DRAWING	SİSTEM KODU SYSTEM CODE	ÜRÜNÜN ADI DESCRIPTIONL
	WH.02.01	CEPHE GİZLİ KANAT KOLU HANDLE FOR FACADE WINDOWS

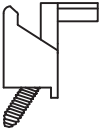
AÇILIM AKSESUARLARI / OPENING ACCESSORIES

ÜRÜN ÇİZİMİ DRAWING	SİSTEM KODU SYSTEM CODE	ÜRÜNÜN ADI DESCRIPTIONL
	WH.01.11	AYARLI KARŞILIK ADJUSTABLE KEEPER
	WH.01.12	TİJ PİMİ PIN

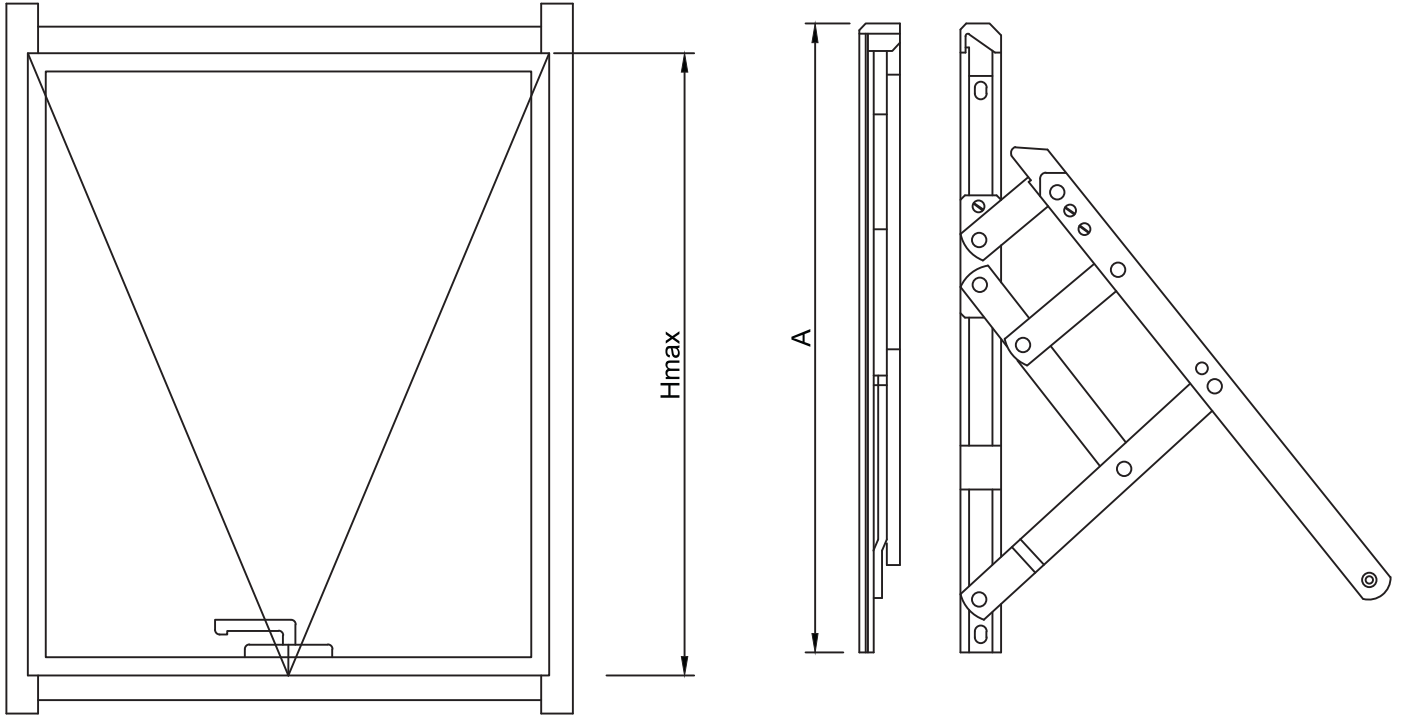

SİSTEM KODU	MAKAS BOYU A	MAKS. KANAT AĞIRLIĞI(kg)	MAKS. KANAT YÜKSEKLİĞİ H (mm)	AÇILMA AÇISI X°
MF.01.001	259 mm (10")	34,5	660	50°
MF.01.002	412 mm (16")	42	762	30°
MF.01.003	567 mm (22")	80	1500	20° - 45°
MF.01.004	690 mm (27")	180	2500	20°
MF.01.005	711 mm (28")	100	2200	15°



Aldom
G R O U P

ares architectural
systems®

aresbond®
U.S.A
Aluminum Composite Panels

Aldom
A L ũ m i n y u m

Aldom Alüminyum San. Tic. A.Ş.

Factory

Veliköy Sanayi Bölgesi Osman Uzun Caddesi
17.ve 20.Sokak Çerkezköy / TEKİRDAĞ

T: +90 (282) 746 14 20 (Pbx)

F: +90 (282) 746 14 27

E-mail: info@aldom.com.tr

www.aldom.com.tr

